



# MAGIS COMBO V2

Hybrid heat pump



# MAGIS COMBO V2

Heat pump and condensing: the intelligence and efficiency of hybrids

MAGIS COMBO V2 is the new hybrid heat pump that **heats, cools and produces hot water with an internal condensing unit designed to meet the highest demands.**

The new outdoor condensing unit is available in 3 single-phase versions: 4, 6 and 9 kW with refrigerant R32 (the most ecological) that guarantees high efficiency in all operating conditions. The internal unit is equipped with a condensing generator (27,3 kW for hot water production and 24 kW for heating) and an integrated hydronic module that controls the exchange of energy between the refrigeration circuit and the water circuit.

MAGIS COMBO V2 takes up **little space** and, compared to condensing boiler, allows for **significant energy saving** thanks to its high energy efficiency. **It is particularly well suited to new homes** built with high insulation criteria and **an excellent solution when replacing** old generators on medium and high-temperature systems, as its heating temperature can reach **up to 80 °C.**

The system comes in two versions:

## MAGIS COMBO V2 (combi version)

Connection **in series** to a separate storage tank makes it possible to add solar thermal for domestic hot water production. The solar probe kit is optional.

## MAGIS COMBO PLUS V2 (heating only version)

The internal unit is designed for combination with a separate storage tank unit for domestic hot water (optional) in order to satisfy large sanitary demands



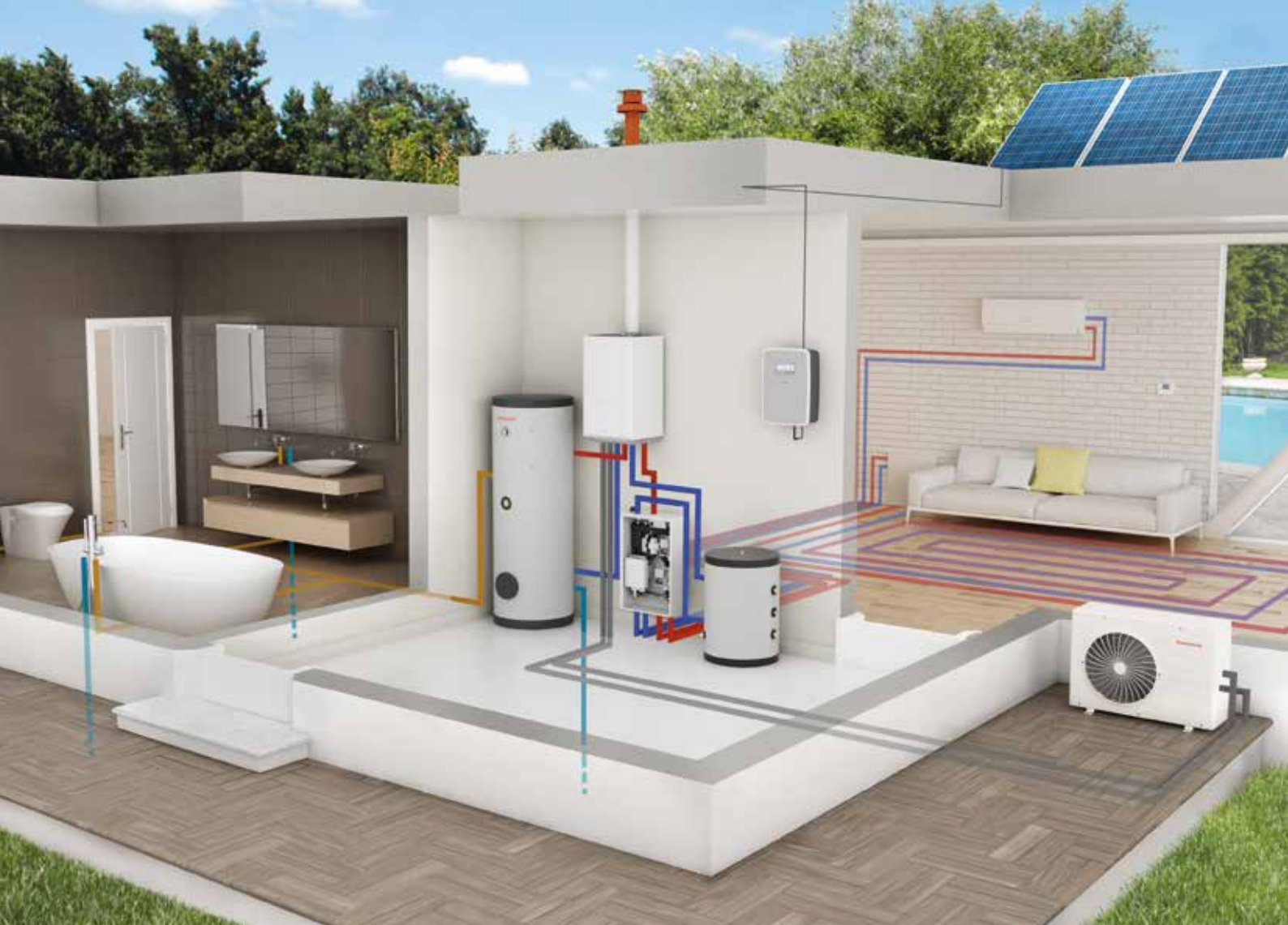

### **MORE VALUE TO PROPERTY**

MAGIS COMBO V2 allows to achieve very high energy classes in new homes and to improve the class energy of the building /system on the existing ones. This increase the value per square meter of the home: an investment that pays off immediately.

### **SPACE-SAVING SOLUTIONS**

The generators are well integrated to give an advantage in terms of installation and reduce overall space needs. MAGIS COMBO PLUS V2 (using specific accessories) can also be inserted inside of the SOLAR CONTAINER COMBO (recessed frame) or combined with the new SUPER TRIO system, both in the recessed frame (CONTAINER for SUPER TRIO) and indoor in a dedicated technical box (DOMUS CONTAINER for SUPER TRIO) with rigorous and clean aesthetics.

### **OPTIMIZATION OF ELECTRICITY CONSUMPTION**

Suitable to combine with photovoltaic systems to take advantage of the free energy of the sun, increasing savings in the most way ecological.

### **PROTECTION AGAINST FREEZING**

MAGIS COMBO V2 split solution is well suited to the design of systems in very cold areas. These systems require installation by qualified professionals with F-GAS license for connection of refrigeration circuit between the two units.

### **INTEGRATED INTELLIGENT ELECTRONICS**

In MAGIS COMBO V2 condensing boiler and heat pump work together to save up to 40% on consumptions. The circuit board assigns priority to internal unit or heat pump according to weather conditions and plant request to ensure top performance in any season exploit renewable energy.





## MAIN FEATURES INTERNAL UNIT

**72 plates R32 / water exchanger**

**Stainless steel condensing module**

**10 litres expansion vessel**

**Flowswitch** that activates heat pump unit just if the water flow rate is enough

**Hydraulic group – 7 head m.w.c. low consumption circulator for heat pump unit** (in the PLUS version can manage also DHW mode)

**Hydraulic group - 7 head m.w.c. low consumption circulator for condensing internal unit circuit**

**New PCB prearranged to manage 3 zones,** one direct and two mixed temperature

System Controller (optional) to manage systems with more zones

**Standard shut off knobs with 3/4" filter as standard**



AUDAX PRO 4 V2

## MAIN FEATURES EXTERNAL UNIT (AUDAX PRO V2)

**Inverter technology rotative compressor**

Preloaded refrigerant **GAS R32**

**Shut off knobs R32 as standard**

**Air finned heat exchanger** (with single fan)

**Electronic lamination valve bi-flow**

**4-way valve for cycle inversion**

**Heating and cooling operation** (reversible)

Possible **installation outdoor** without protection

## Key

- |   |  |
|---|--|
| 1 | MAGIS COMBO V2                               |
| 2 | Buffer tank (to be dimensioned)              |
| 3 | Diverter valve for heating/cooling switching |
| 4 | Wall-hung hydronic fancoil HYDRO 3           |

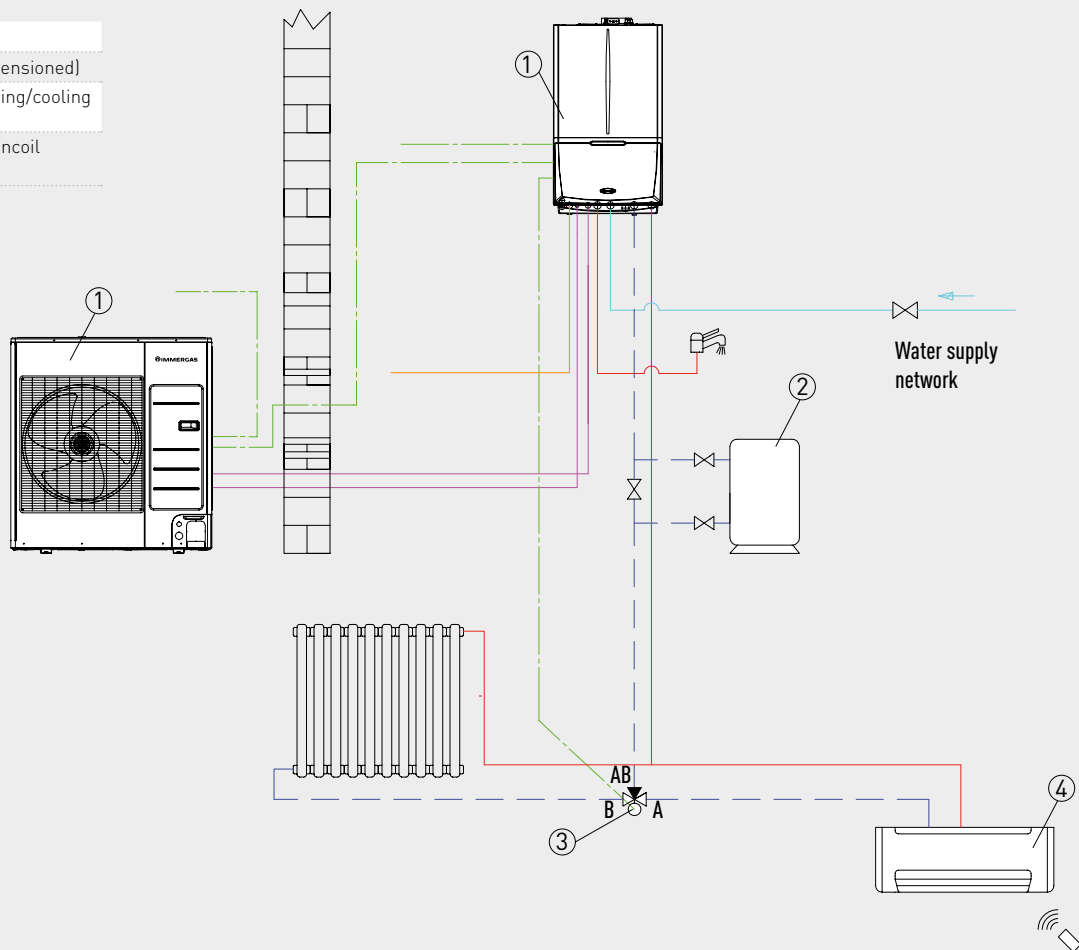

### EXAMPLE OF CONFIGURATION FOR MAGIS COMBO V2 IN THE REPLACING OF AN OLD EXISTING PLANT

Installation suggested even in case of replacing existing gas boiler in a plant with fancoils or with radiators operating with medium temperature.

**MAGIS COMBO V2** can manage a three-way valve to heat the room with radiant panels or radiators and to cool with fancoils.

#### Heating mode

MAGIS COMBO V2 is switched on by a request from the plant. If the time required to reach full capacity is longer than the set time, condensing unit will be triggered.

#### Cooling mode

The heat pump of MAGIS COMBO V2 is switched on by the request from the zone that works in cooling fancoil).

#### Domestic hot water mode

With MAGIS COMBO V2 the instantaneous production of DHW is up to the condensing unit.

*NB: a water content of 30 litres is enough ; if this minimum content is not guaranteed, consider the addition of buffer tank.*



## Key

- |    |   |
|----|---|
| 1  | MAGIS COMBO PLUS V2   |
| 2  | Photovoltaic inverter (with output contact for photovoltaic production) |
| 3  | Photovoltaic panel  |
| 4  | DHW Thermostatic mixing valve   |
| 5  | DHW storage tank OMNISTOR   |
| 6  | Storage tank NTC probe (as standard)                                    |
| 7  | Safety inlet kit (not included)   |
| 8  | Buffer tank (to be dimensioned)   |
| 9  | Distribution manifold kit (1 direct and 1 mixed zone)                   |
| 10 | HYDRO FS floor standing hydronic fancoil                                |

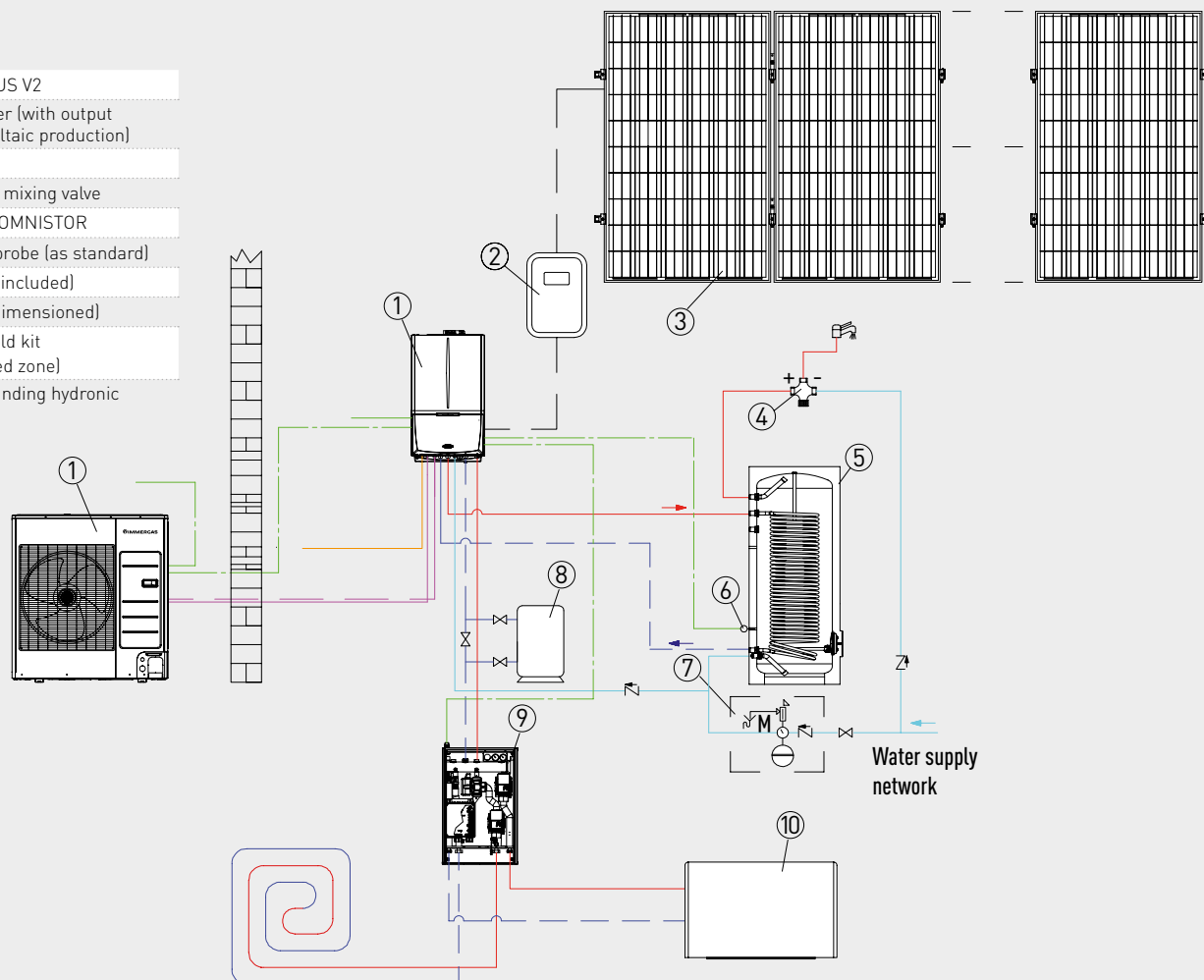

## EXAMPLE OF CONFIGURATION FOR MAGIS COMBO PLUS V2 WITH TWO SYSTEM ZONES AND PHV SYSTEM

Ideal installation in new homes to achieve high energy efficiency rating and large % of power from Renewable Energy Sources.

### Heating mode

MAGIS COMBO PLUS V2 is switched on by a request from one of the two system zones. If the time required to reach full capacity is longer than the set time, condensing unit will be triggered.

### Cooling mode

The heat pump of MAGIS COMBO PLUS V2 is switched on by a request from one of the two system zones.

### Domestic hot water mode

With MAGIS COMBO PLUS V2, heat pump and condensing unit operate on a single flow/return circuit in the storage tank unit. For domestic hot water production, the system features the possibility of choosing between two options:

- operation with priority to domestic hot water over the system;
- simultaneous operation, favouring the internal condensing unit for domestic hot water.

*NB: a water content of 30 litres is enough ; if this minimum content is not guaranteed, consider the addition of buffer tank.*



Technical characteristics	Unit of measurement	MAGIS COMBO 4 V2	MAGIS COMBO 6 V2	MAGIS COMBO 9 V2
Code N.G.		3.030609	3.030611	3.030613
Code L.P.G.		3.030609GPL	3.030611GPL	3.030613GPL
Energetic class in heating at 55 °C		A++	A++	A++
Energetic class in heating at 35 °C		A+++	A+++	A+++
Energetic class DHW/load profile		A/XL	A/XL	A/XL
Refrigerant quantity (R32)	g	1.200	1.200	1.400
Heating capacity (system water 35 °C)	kW	4,40	6,00	9,00
Heating capacity (system water 45 °C)	kW	4,20	5,40	8,60
Heating capacity (system water 55 °C)	kW	3,90	4,80	8,00
Flow temperature range (C.H.)	°C	20-65	20-65	20-65
Outside air temperature range (C.H.)	°C	-25/35	-25/35	-25/35
COP (system water 35 °C)		5,20	4,92	4,81
COP (system water 45 °C)		3,85	3,58	3,69
COP (system water 55 °C)		2,95	2,65	2,93
Cooling capacity (system water 18 °C)	kW	5,00	6,50	8,70
Cooling capacity (system water 7 °C)	kW	3,60	4,70	6,50
Flow temperature range (cooling)	°C	5 - 25	5 - 25	5 - 25
Outside air temperature range (cooling)	°C	10/46	10/46	10/46
EER (system water 18 °C)		4,59	4,42	4,12
EER (system water 7 °C)		3,24	3,26	3,33
Power supply	V - Hz	230-50	230-50	230-50
Maximum power absorbed	W	2.100	2.900	4.300
Condensing unit weight (empty)	kg	46,5	46,5	73,0
DATA REFERRED TO INTERNAL CONDENSING UNIT				
Pump absorbed power (condensing unit circuit)	W	60	60	60
Pump absorbed power (refrigerant circuit)	W	75	75	75
Maximum nominal heat input (D.H.W. mode)	kW	28,1	28,1	28,1
Maximum nominal heat input (C.H. mode)	kW	24,9	24,9	24,9
Minimum nominal heat input	kW	5,1	5,1	5,1
Maximum nominal heat output (D.H.W. mode)	kW	27,3	27,3	27,3
Maximum nominal heat output (C.H. mode)	kW	24,0	24,0	24,0
Minimum nominal heat output	kW	4,8	4,8	4,8
Efficiency at nominal heat output (80/60 °C)	%	96,2	96,2	96,2
Efficiency at 30% of load (80/60 °C)	%	98,4	98,4	98,4
Efficiency at nominal heat output (40/30 °C)	%	106,8	106,8	106,8
Efficiency at 30% of load (40/30 °C)	%	106,1	106,1	106,1
Flow temperature range (C.H.)	°C	20-80	20-80	20-80
NO <sub>x</sub> class		6	6	6
Flow rate capacity in continuous duty (Δt 30 °C)	l/min	13,1	13,1	13,1
Central heating expansion vessel capacity nominal (real)	l	10 (8,3)	10 (8,3)	10 (8,3)
Central heating circuit max pressure	bar	3	3	3
Appliance water content	l	2,8	2,8	2,8
Weight (empty)	kg	55,8	55,8	55,8

Referred to the following conditions:

Environment	Heating [°C]	Cooling [°C]
T system water (R/M) - air (bs/bu)	30/35 - 7/6	23/18 - 35 (bs)
T system water (R/M) - air (bs/bu)	40/45 - 7/6	12/7 - 35 (bs)

For more information consult the technical sheet or the website [immergas.com](http://immergas.com)





Technical characteristics	Unit of measurement	MAGIS COMBO 4 PLUS V2	MAGIS COMBO 6 PLUS V2	MAGIS COMBO 9 PLUS V2
Code N.G.	N.G.	3.030615	3.030617	3.030619
Code L.P.G.	L.P.G.	3.030615GPL	3.030617GPL	3.030619GPL
<b>Energetic class in heating at 55 °C</b>		<b>A++</b>	<b>A++</b>	<b>A++</b>
<b>Energetic class in heating at 35 °C</b>		<b>A+++</b>	<b>A+++</b>	<b>A+++</b>
<b>Refrigerant quantity (R32)</b>	<b>g</b>	<b>1.200</b>	<b>1.200</b>	<b>1.400</b>
Heating capacity (system water 35 °C)	kW	4,40	6,00	9,00
Heating capacity (system water 45 °C)	kW	4,20	5,40	8,60
Heating capacity (system water 55 °C)	kW	3,90	4,80	8,00
Flow temperature range (C.H.)	°C	20-65	20-65	20-65
Outside air temperature range (C.H.)	°C	-25/35	-25/35	-25/35
COP (system water 35 °C)		5,20	4,92	4,81
COP (system water 45 °C)		3,85	3,58	3,69
COP (system water 55 °C)		2,95	2,65	2,93
Cooling capacity (system water 18 °C)	kW	5,00	6,50	8,70
Cooling capacity (system water 7 °C)	kW	3,60	4,70	6,50
Flow temperature range (cooling)	°C	5 - 25	5 - 25	5 - 25
Outside air temperature range (cooling)	°C	10/46	10/46	10/46
EER (system water 18 °C)		4,59	4,42	4,12
EER (system water 7 °C)		3,24	3,26	3,33
Power supply	V - Hz	230-50	230-50	230-50
Maximum power absorbed	W	2.100	2.900	4.300
Condensing unit weight (empty)	kg	46,5	46,5	73,0
DATA REFERRED TO INTERNAL CONDENSING UNIT				
Pump absorbed power (condensing unit circuit)	W	60	60	60
Pump absorbed power (refrigerant circuit)	W	75	75	75
Maximum nominal heat input (D.H.W. mode)	kW	28,1	28,1	28,1
Maximum nominal heat input (C.H. mode)	kW	24,9	24,9	24,9
Minimum nominal heat input	kW	5,1	5,1	5,1
Maximum nominal heat output (D.H.W. mode)	kW	27,3	27,3	27,3
Maximum nominal heat output (C.H. mode)	kW	24,0	24,0	24,0
Minimum nominal heat output	kW	4,8	4,8	4,8
Efficiency at nominal heat output (80/60 °C)	%	96,2	96,2	96,2
Efficiency at 30% of load (80/60 °C)	%	98,4	98,4	98,4
Efficiency at nominal heat output (40/30 °C)	%	106,8	106,8	106,8
Efficiency at 30% of load (40/30 °C)	%	106,1	106,1	106,1
Flow temperature range (C.H.)	°C	20-80	20-80	20-80
NO <sub>x</sub> class		6	6	6
Central heating expansion vessel capacity (real)	l	10 (8,3)	10 (8,3)	10 (8,3)
Central heating circuit max pressure	bar	3	3	3
Appliance water content	l	2,5	2,5	2,5
Weight (empty)	kg	55,0	55,0	55,0

Referred to the following conditions:

Environment	Heating [°C]	Cooling [°C]
T system water (R/M) - air (bs/bu)	30/35 - 7/6	23/18 - 35 (bs)
T system water (R/M) - air (bs/bu)	40/45 - 7/6	12/7 - 35 (bs)

For more information consult the technical sheet or the website [immergas.com](http://immergas.com)



MAGIS COMBO V2

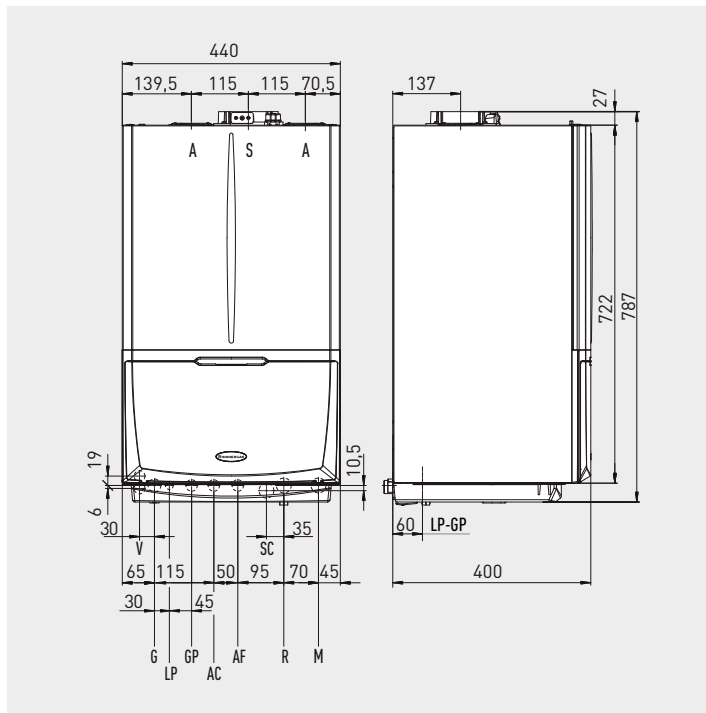

Key

V	Electrical connection
G	Gas supply
LP	Liquid refrigerant
GP	Gas refrigerant
AC	Domestic hot water outlet
AF	Domestic cold water inlet
SC	Condensate drain (minimum internal diameter 13 mm)
R	System return
M	System flow
A/S	Outlet/Inlet
A	Inlet
S	Outlet

Hydraulic connections

R32		Gas	D.H.W.		System	
LP	GP	G	AC	AF	R	M
1/4"	5/8"	3/4"	1/2"	1/2"	3/4"	3/4"

MAGIS COMBO PLUS V2

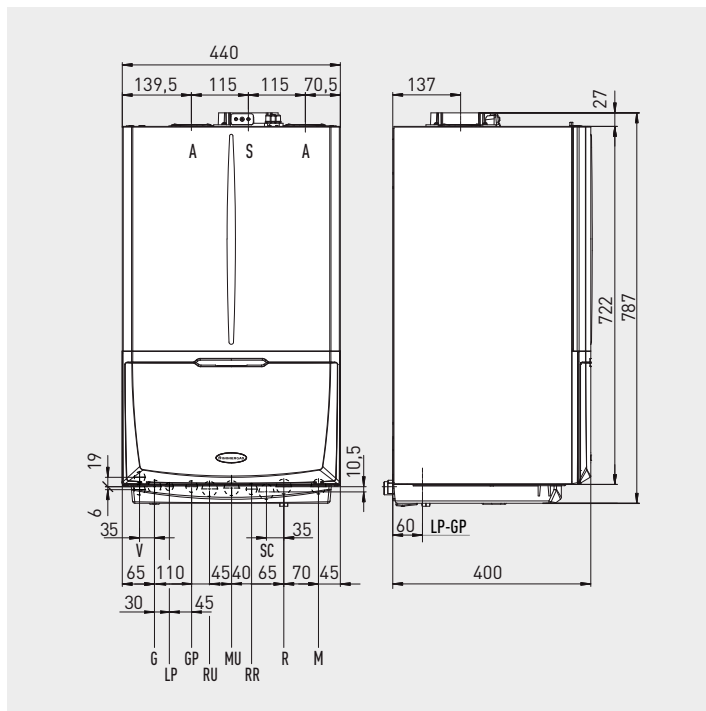

Key

V	Electrical connection
G	Gas supply
LP	Liquid refrigerant
GP	Gas refrigerant
RU	Return storage tank
MU	Flow storage tank
RR	System filling
SC	Condensate drain (minimum internal diameter 13 mm)
R	System return
M	System flow
A/S	Outlet/Inlet
A	Inlet
S	Outlet

Hydraulic connections

R32		Gas	D.H.W.		System
LP	GP	G	MU - RU	RR	R - M
1/4"	5/8"	3/4"	3/4"	1/2"	3/4"



To ensure correct installation of internal unit, the air inlet/flue outlet pipes kit must be selected from the Immergas "Green Series".

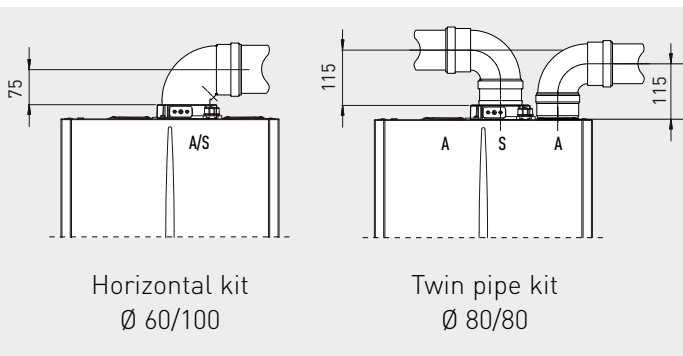

Horizontal kit  
Ø 60/100

Twin pipe kit  
Ø 80/80

External unit AUDAX PRO 4/6 V2 for MAGIS COMBO/PLUS V2

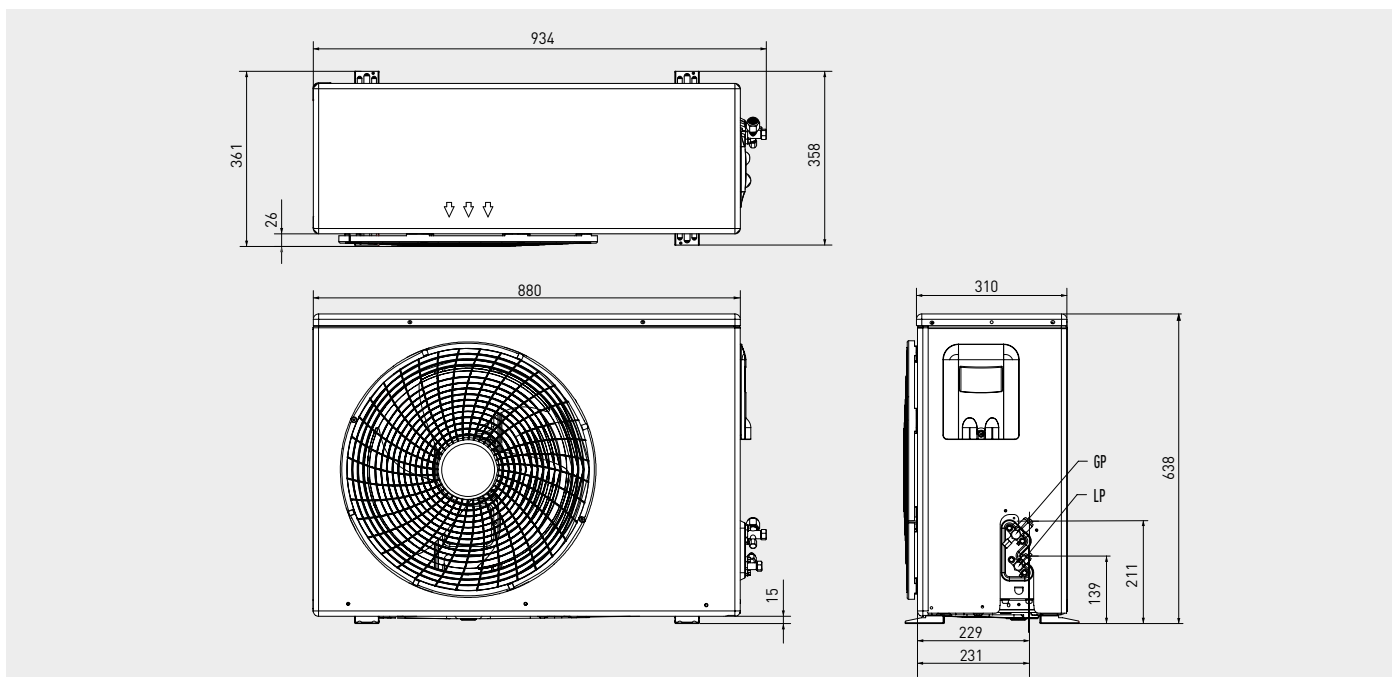

Hydraulic connections

R32

GP (gas refrigerant)

5/8" (15,88 mm)

LP (liquid refrigerant)

1/4" (6,35 mm)

External unit AUDAX PRO 9 V2 for MAGIS COMBO/PLUS V2

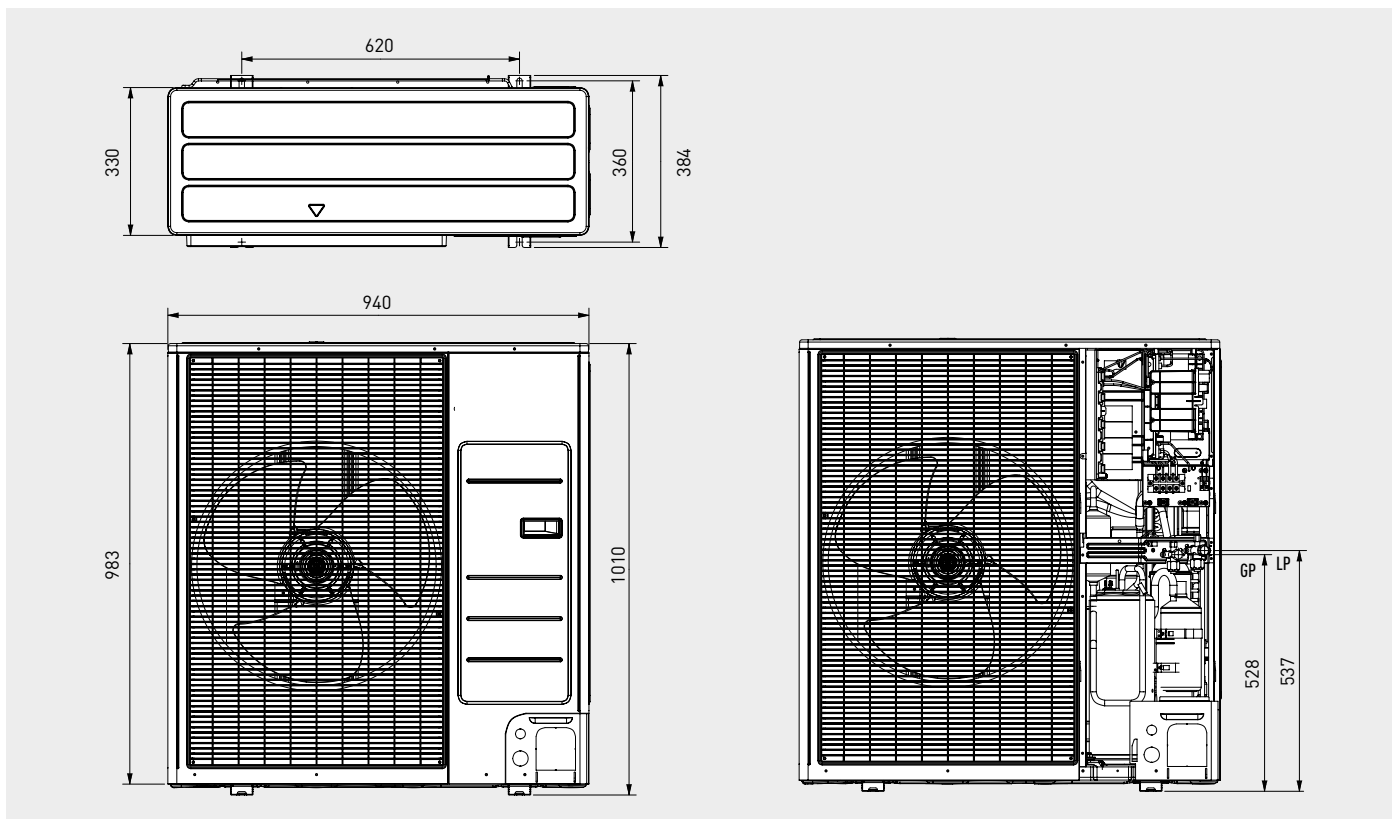

Hydraulic connections

R32

GP (gas refrigerant)

5/8" (15,88 mm)

LP (liquid refrigerant)

1/4" (6,35 mm)

### Minimum distances for AUDAX PRO V2 installation

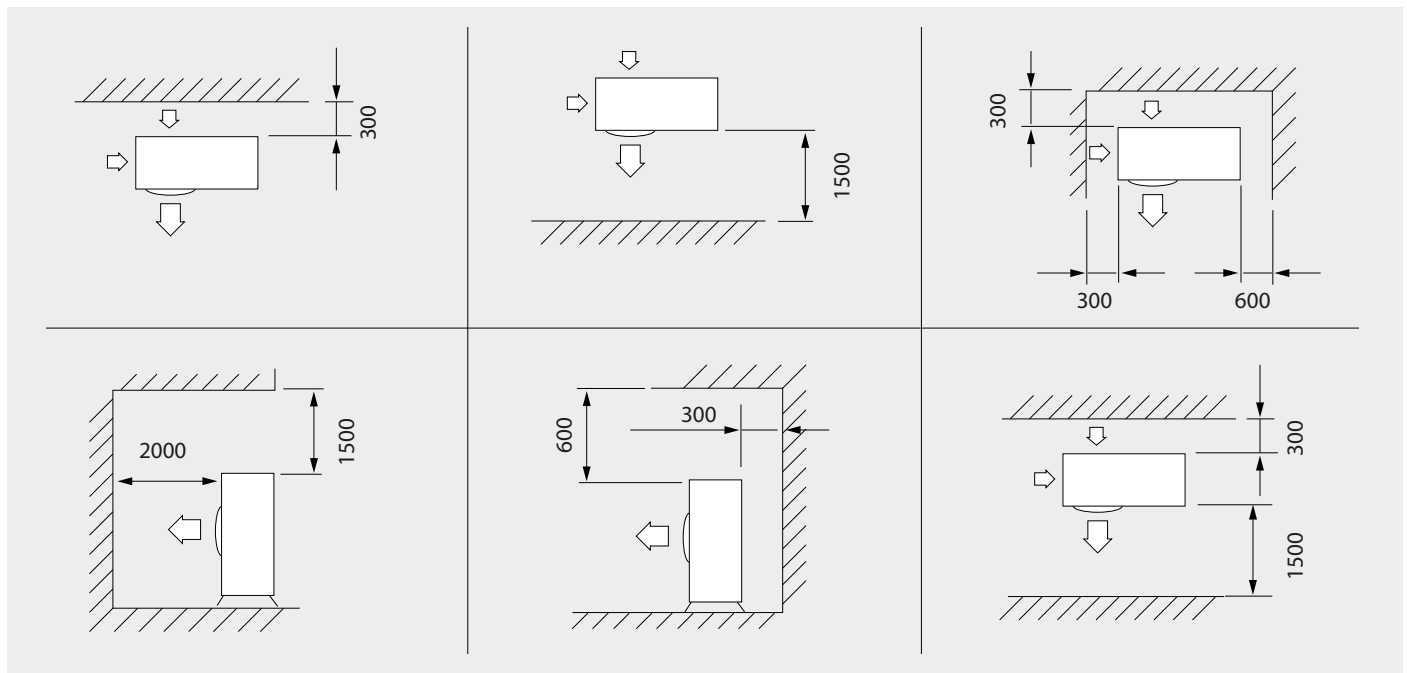

**TECHNICAL NOTE: System minimum water content:**

To facilitate proper execution of the heat pump defrost cycles, a minimum water content in the system is required, which must be **30 litres** for all kinds of system. So attention must be paid to the systems divided over several zones, where the water content available to the machine changes continuously. This is why it may be necessary to provide a heating flywheel that guarantees normal operation with systems divided into zones (with variable water content in circulation). This minimum content also guarantees proper operation with fan coils used for cooling (a condition in which the flow temperature is very low and has significant heat load variations that vary the number of active fan coils). It is also important to check that the dehumidifier line has a minimum of **3 l/kW** of the machine (dehumidifier hydraulic circuit connection).

**Technical note - Installation of the refrigeration lines:**

The length of the pipes between the outdoor and indoor units and the difference in height must not exceed the specified limits. The maximum lengths of the refrigeration lines are listed below, based on the heat pump model and the type of installation:

	MAGIS COMBO/PLUS 4/6 V2	MAGIS COMBO/PLUS 9 V2
Length limit*	≤ 30 m	≤ 35 m
Difference in height limit (with internal unit lower than outdoor unit)	≤ 20 m	≤ 20 m
Difference in height limit (with internal unit higher than outdoor unit)	≤ 15 m	≤ 15 m

\* With the preload it is possible to develop maximum lengths of 15 m. Longer lengths require the integration of R32 (20 g/m) in addition to the one already preloaded.

**Flow rate / head graph  
CONDENSING BOILER CIRCUIT MAGIS COMBO/PLUS V2**

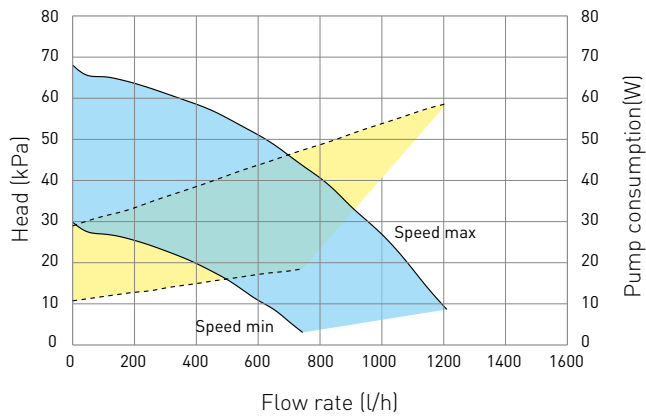

**Key**

- Available head in the system
- Pump consumption

**Flow rate / head graph  
HEAT PUMP CIRCUIT MAGIS COMBO V2**

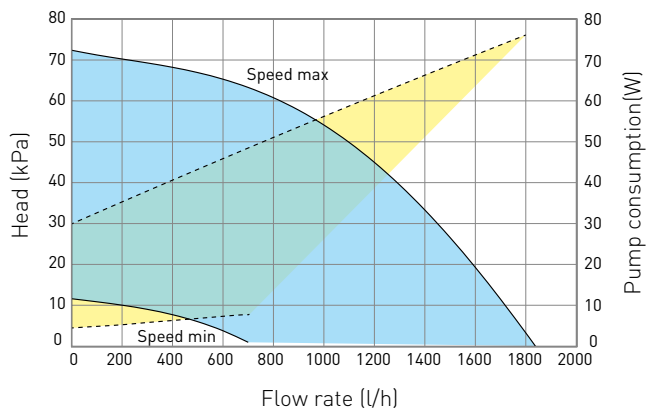

**Flow rate / head graph  
HEAT PUMP CIRCUIT MAGIS COMBO PLUS V2**

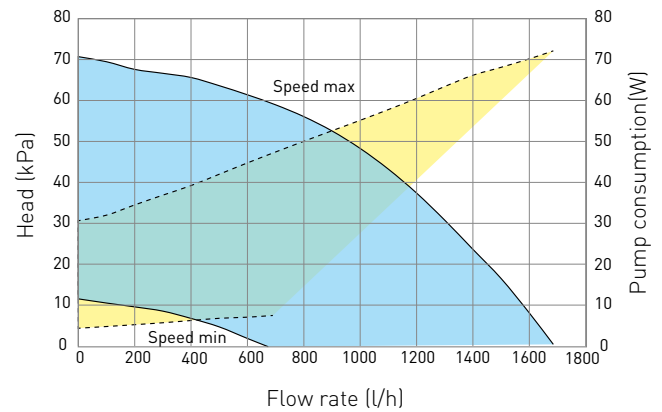

# MAGIS COMBO PLUS V2 with SUPER TRIO

Recessed or in-house solution for high need of domestic hot water



## ESSENTIAL COMPONENTS

### BOX

Depending on the installation requirement, it is possible to choose between:

- CONTAINER for SUPER TRIO (code 3.030394) for recessed installation
- DOMUS CONTAINER for SUPER TRIO (code 3.030393) for indoor installation

### HYBRID PUMP MODEL

It is possible to choose from the following models:

- MAGIS COMBO 4 PLUS V2 (code 3.030615)
- MAGIS COMBO 6 PLUS V2 (code 3.030617)
- MAGIS COMBO 9 PLUS V2 (code 3.030619)
- MAGIS COMBO 4 PLUS V2 GPL (code 3.030615GPL)
- MAGIS COMBO 6 PLUS V2 GPL (code 3.030617GPL)
- MAGIS COMBO 9 PLUS V2 GPL (code 3.030619GPL)

### HYDRONIC GROUP SUPER TRIO (code 3.030395)

Composed by:

- DHW storage tank in stainless steel 250 litres of capacity (class C) with single coil
- 30 liter buffer tank in stainless steel
- Hydraulic distribution unit that includes: hydraulic manifold and 1 pump (direct zone)
- Electrical wiring, antifreeze heating cable and NTC probe for storage tank
- DHW expansion vessel 16 litres, safety valve 8 bar and thermostatic mixing valve
- Support bracket for internal unit

### MAGIS COMBO PLUS WITH SUPER TRIO CONNECTION KIT (code 3.030599)

Composed by: hydraulic and refrigerant gas fittings specific for MAGIS COMBO PLUS V2

*N.B.: For specific option kit see page 33.*



# MAGIS COMBO PLUS V2 in SOLAR CONTAINER COMBO

Recessed solution for medium-large buildings dimensions





## ESSENTIAL COMPONENTS

### BOX

SOLAR CONTAINER COMBO (code 3.028187) for recessed installation

### HYBRID PUMP MODEL

It is possible to choose from the following models:

- MAGIS COMBO 4 PLUS V2 (code 3.030615)
- MAGIS COMBO 6 PLUS V2 (code 3.030617)
- MAGIS COMBO 9 PLUS V2 (code 3.030619)
- MAGIS COMBO 4 PLUS V2 GPL (code 3.030615GPL)
- MAGIS COMBO 6 PLUS V2 GPL (code 3.030617GPL)
- MAGIS COMBO 9 PLUS V2 GPL (code 3.030619GPL)

### HYDRONIC KIT FOR MAGIS COMBO PLUS IN SOLAR CONTAINER COMBO (code. 3.027867)

Composed by:

- DHW storage tank in stainless steel 160 litres of capacity (class C) with single coil
- Hydraulic distribution unit that includes: hydraulic manifold and 1 pump (direct zone)
- Electrical wiring, antifreeze heating cable and NTC probe for storage tank
- DHW expansion vessel 8 litres, safety valve 8 bar and thermostatic mixing valve
- Hydraulic and refrigerant gas fitting specific for MAGIS COMBO PLUS V2
- Support bracket for internal unit

*N.B.: For specific option kit see page 34.*



Recessed frame CONTAINER for SUPER TRIO

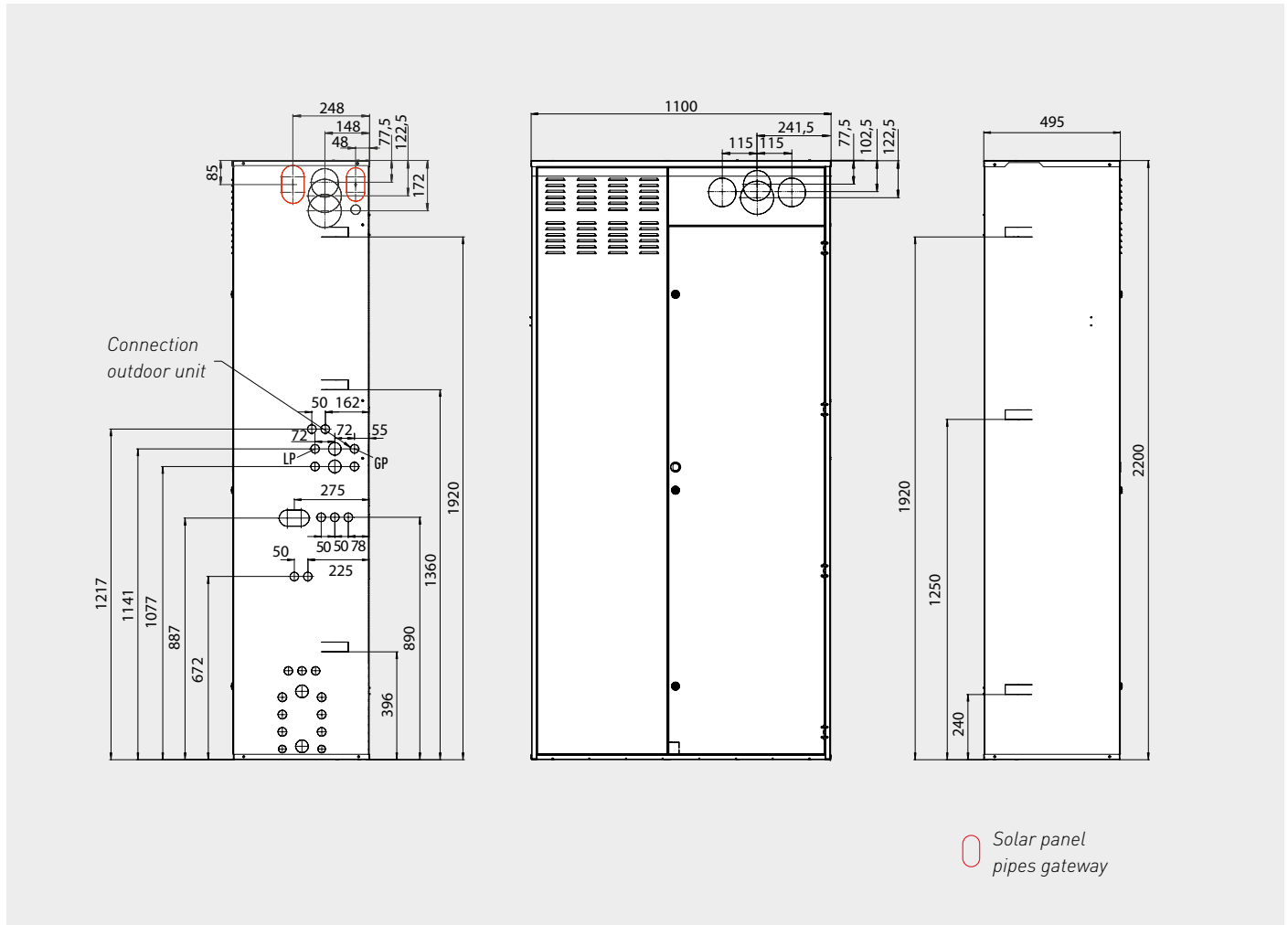

**Pay attention:** Gateway for gas R32 (GP and LP) connections is only on the right side of CONTAINER for SUPER TRIO.

UPPER FLUE PIPES CONNECTION

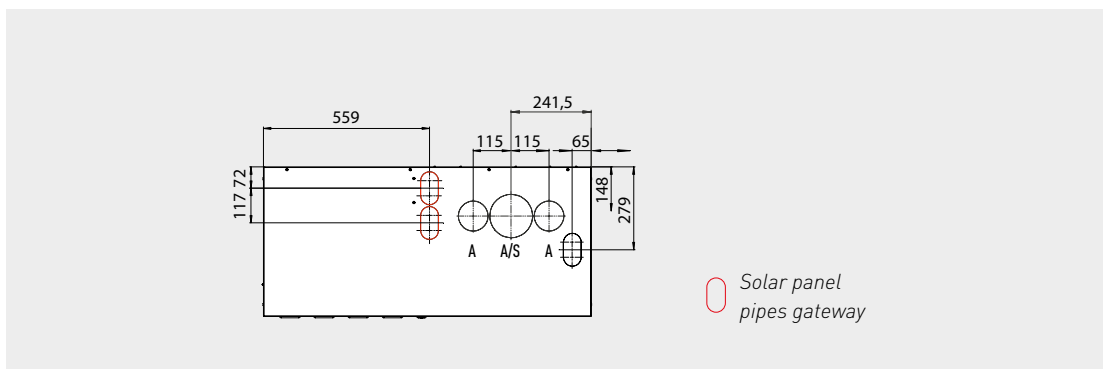

**A/S** Inlet/outlet - **A** Inlet

**Pay attention:** With  $\varnothing$  60/100 horizontal concentric flue kit it is always necessary to use the Flanged stub-pipe kit  $\varnothing$  60/100 (code 3.012086), 90° bend  $\varnothing$  60/100 kit (code 3.012093) and Extension pipe kit  $\varnothing$  60/100 0,5 m long (code 3.014643). On the left side of the CONTAINER it is possible to exit just with flue pipes  $\varnothing$  80.

Recessed frame CONTAINER for SUPER TRIO

REAR HYDRAULIC CONNECTION

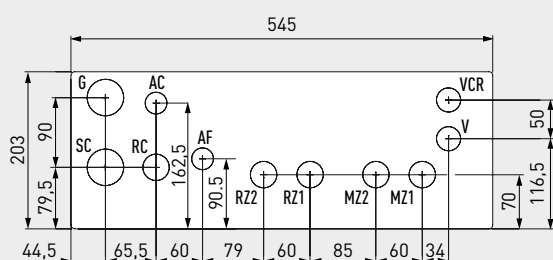

BOTTOM HYDRAULIC CONNECTION

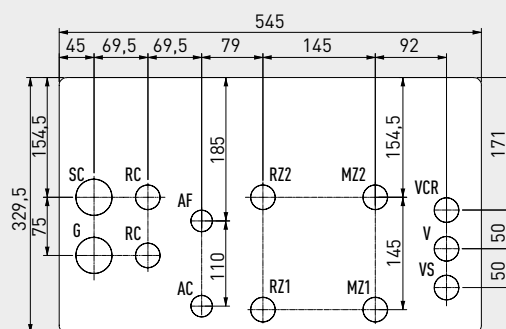

RIGHT LATERAL HYDRAULIC CONNECTION

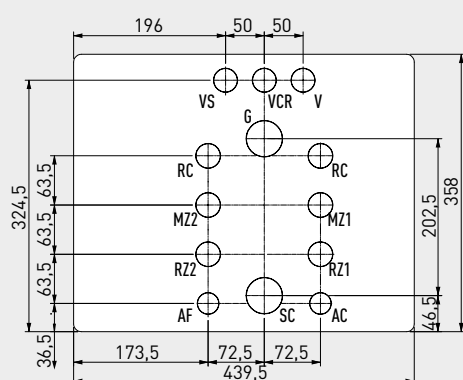

Key

- G Gas supply
- AC Domestic hot water outlet
- AF Domestic cold water inlet
- GP Gas refrigerant
- LP Liquid refrigerant
- MZ1 System delivery zone 1
- RZ1 System return zone 1
- MZ2 System delivery zone 2
- RZ2 System return zone 2
- RC Recirculation kit 1/2"
- SC Condensate drain
- V Electrical connection
- VCR Remote control panel
- VS 3 bar drain valve

**Pay attention:** Dimensions refer to the stickers applied inside the CONTAINER for SUPER TRIO.

	Zone 1 (as standard)	Zone 2 (option kit)
MAGIS COMBO PLUS V2	Direct zone	Mixed zone

Connections

Gas	D.H.W.		System				R32 (for MAGIS COMBO PLUS V2)	
	AC	AF	RZ1	MZ1	RZ2	MZ2	LP	GP
1/2"	1/2"	1/2"	3/4"	3/4"	3/4"	3/4"	1/4" (6,35 mm)	5/8" (15,88 mm)



Technical box DOMUS CONTAINER for SUPER TRIO

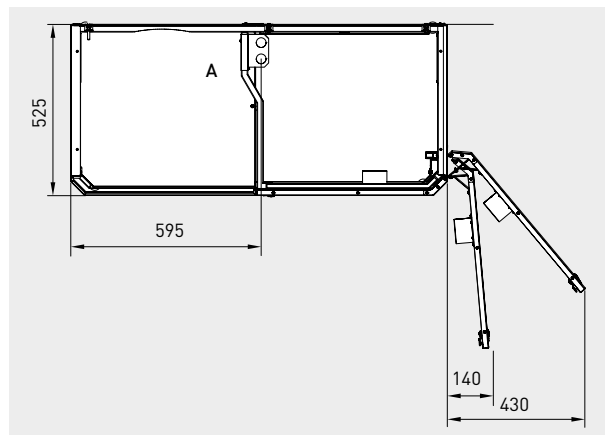
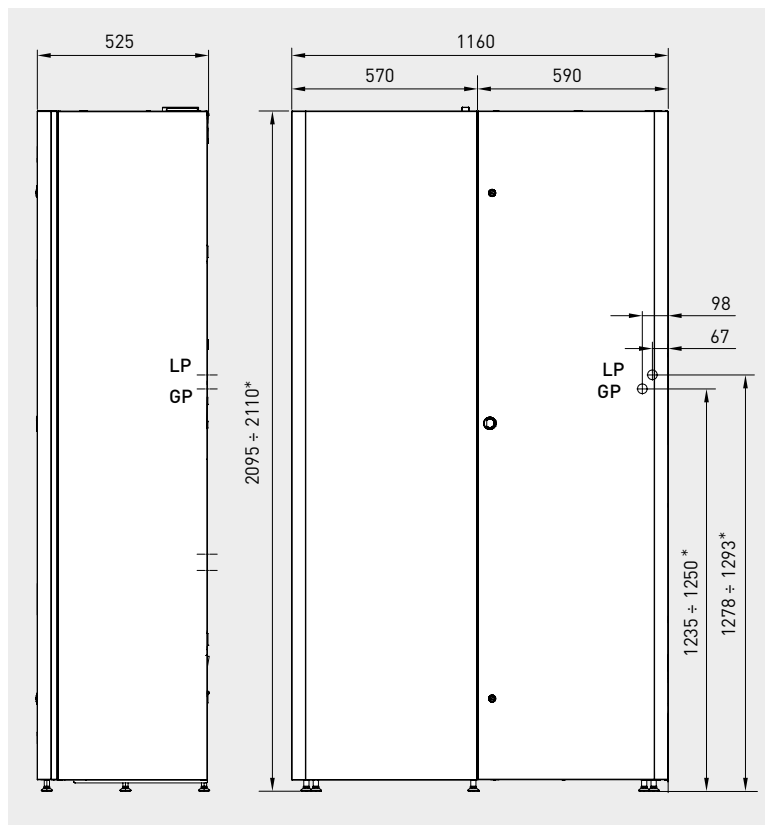

X = 140 cm Minimum dimension in order to open (right side) or disassembly the door  
Y = 430 cm Maximum door opening - not essential -

(\* ) Feet adjustment (from 35 mm to 55 mm) can increase + 15 mm each height measurement.

**Pay attention:** Gateway for gas R32 connections (GP and LP) is only on the rear side of DOMUS CONTAINER for SUPER TRIO.

FLUE PIPES CONNECTION

CONFIGURATION WITH HORIZONTAL CONCENTRIC KIT Ø 60/100

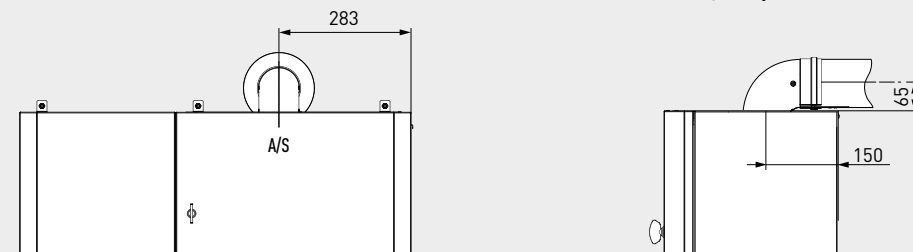

Flanged stub-pipe kit Ø 60/100 code 3.012086  
90° bend Ø 60/100 kit code 3.012093  
Extension pipe kit Ø 60/100 0,5 m long code 3.014643

CONFIGURATION WITH TWIN PIPE KIT Ø 80/80

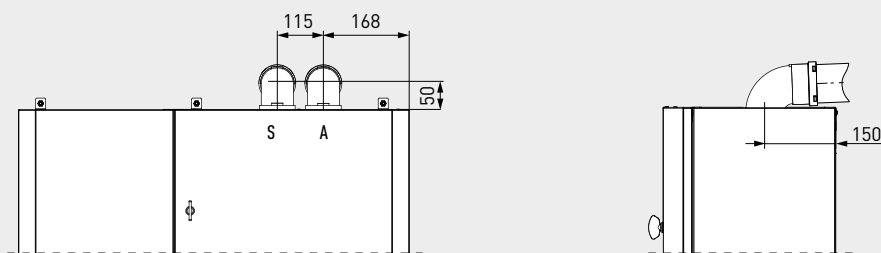

Twin pipe kit Ø 80/80 code 3.012002  
A/S Inlet/outlet - A Inlet - S Outlet

To cover the upper part of the DOMUS CONTAINER and all the additional components it is necessary to use the aesthetic upper cover kit code 3.030484

Technical box DOMUS CONTAINER for SUPER TRIO

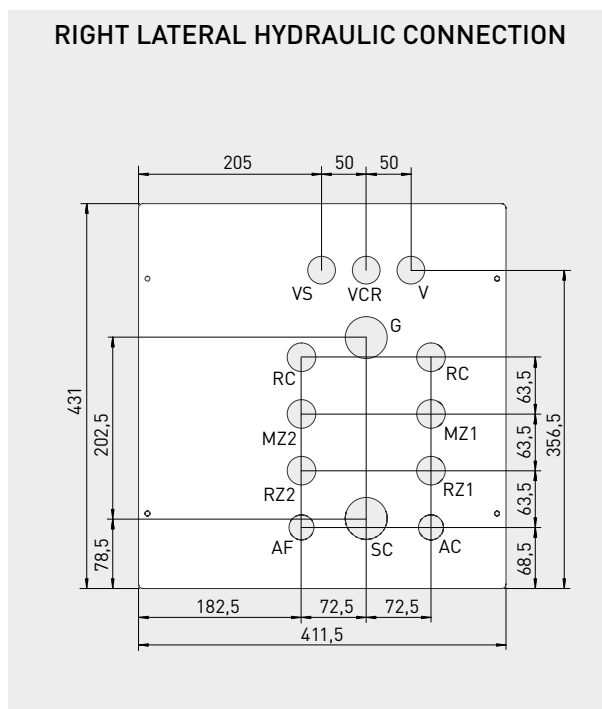
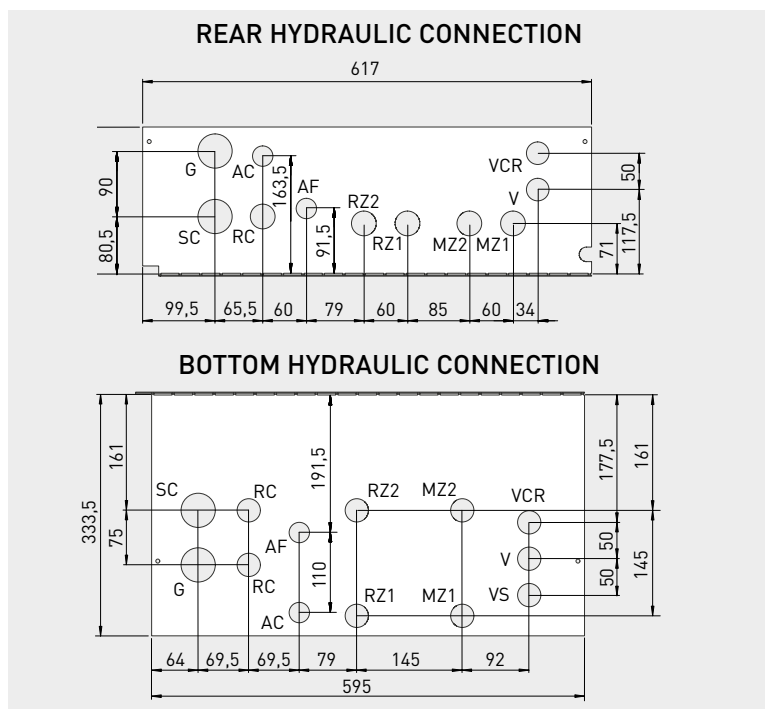

Key

<b>G</b>	Gas supply
<b>AC</b>	Domestic hot water outlet
<b>AF</b>	Domestic cold water inlet
<b>GP</b>	Gas refrigerant
<b>LP</b>	Liquid refrigerant
<b>MZ1</b>	System delivery zone 1
<b>RZ1</b>	System return zone 1
<b>MZ2</b>	System delivery zone 2
<b>RZ2</b>	System return zone 2
<b>RC</b>	Recirculation kit 1/2"
<b>SC</b>	Condensate drain
<b>V</b>	Electrical connection
<b>VCR</b>	Remote control panel
<b>VS</b>	3 bar drain valve

	Zone 1 (as standard)	Zone 2 (option kit)
MAGIS COMBO PLUS V2	Direct zone	Mixed zone

**Pay attention:** Dimensions refer to the stickers applied inside the DOMUS CONTAINER for SUPER TRIO.

Connections

Gas	D.H.W.		System				R32 (for MAGIS COMBO PLUS V2)	
G	AC	AF	RZ1	MZ1	RZ2	MZ2	LP	GP
1/2"	1/2"	1/2"	3/4"	3/4"	3/4"	3/4"	1/4" (6,35 mm)	5/8" (15,88 mm)



Recessed frame SOLAR CONTAINER COMBO

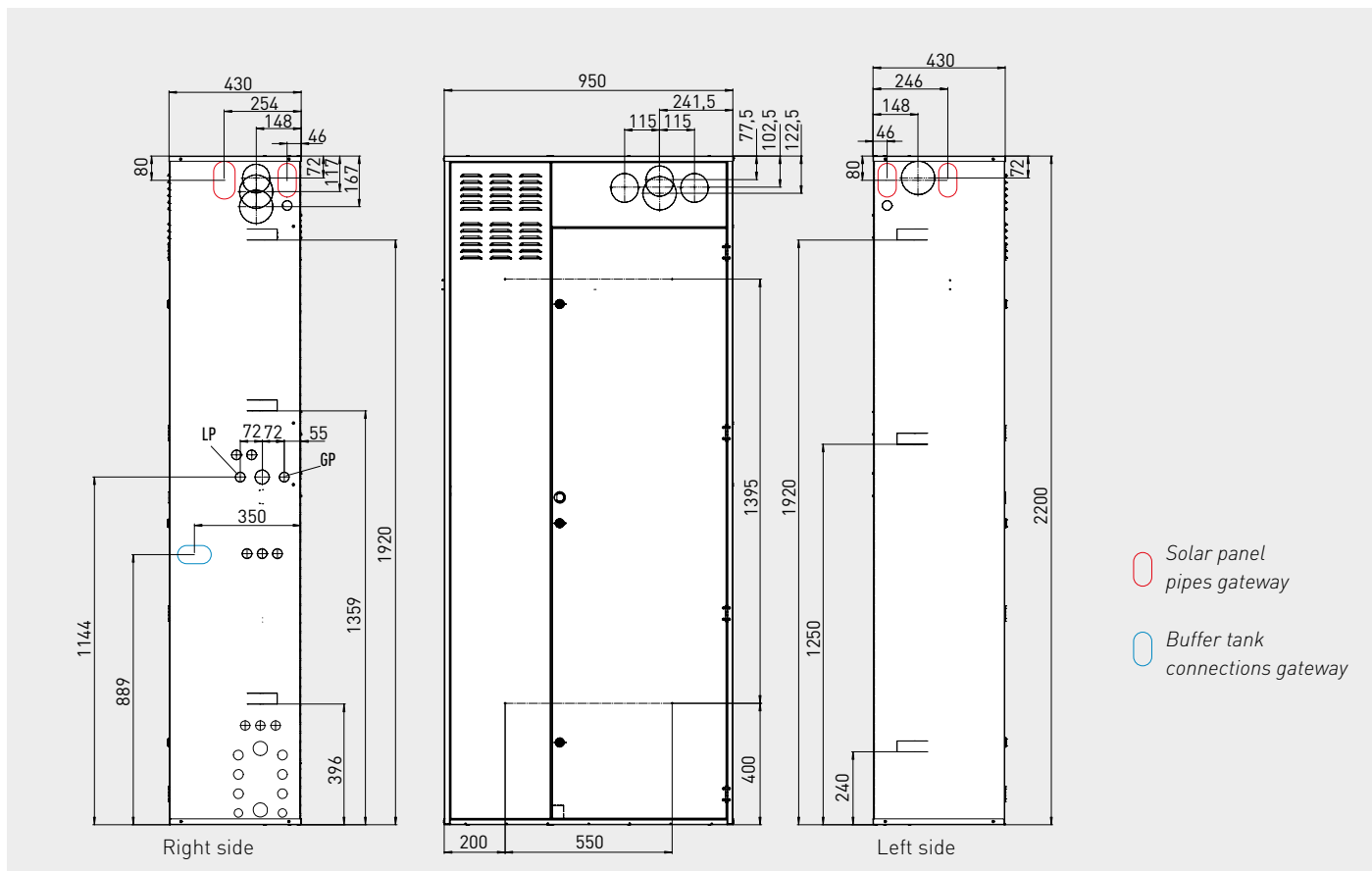

**Pay attention:** Gateway for gas R32 (GP and LP) connections is only on the right side of SOLAR CONTAINER COMBO.

UPPER FLUE PIPES CONNECTION

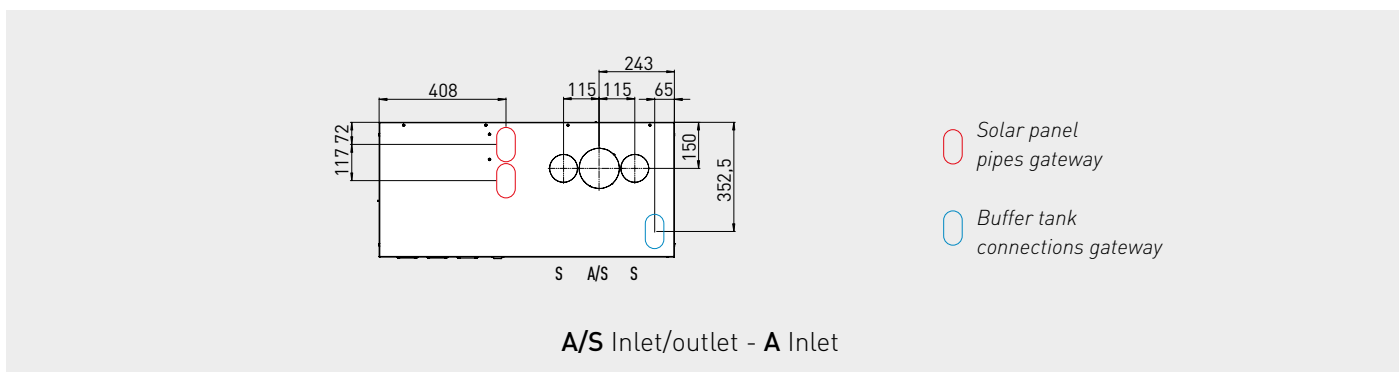

**Pay attention:** With  $\varnothing$  60/100 horizontal concentric flue kit it is always necessary to use the Flanged stub-pipe kit  $\varnothing$  60/100 (code 3.012086), 90° bend  $\varnothing$  60/100 kit (code 3.012093) and Extension pipe kit  $\varnothing$  60/100 0,5 m long (code 3.014643). On the left side of the SOLAR CONTAINER COMBO it is possible to exit just with flue pipes  $\varnothing$  80.

Recessed frame SOLAR CONTAINER COMBO

REAR HYDRAULIC CONNECTION

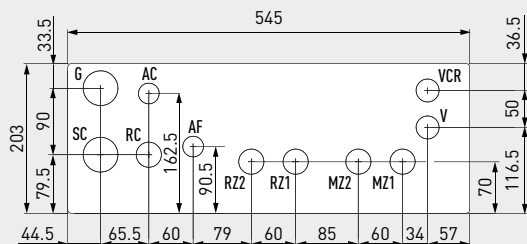

BOTTOM HYDRAULIC CONNECTION

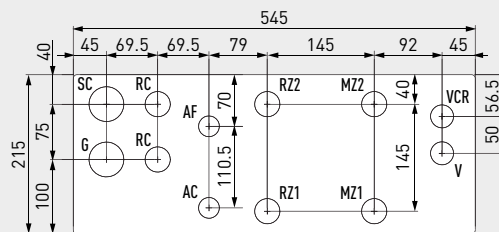

RIGHT LATERAL HYDRAULIC CONNECTION

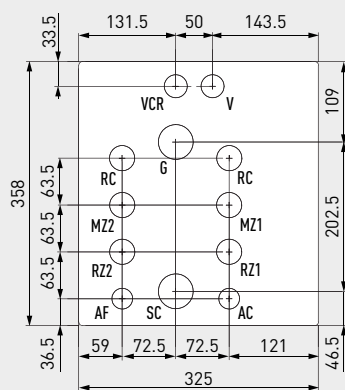

Key

- G** Gas supply
- AC** Domestic hot water outlet
- AF** Domestic cold water inlet
- GP** Gas refrigerant
- LP** Liquid refrigerant
- MZ1** System delivery zone 1
- RZ1** System return zone 1
- MZ2** System delivery zone 2
- RZ2** System return zone 2
- RC** Recirculation kit 1/2"
- SC** Condensate drain
- V** Electrical connection
- VCR** Remote control panel
- VS** 3 bar drain valve

**Pay attention:** Dimensions refer to the stickers applied inside the SOLAR CONTAINER COMBO.

Connections

Gas	D.H.W.		System				R32 (for MAGIS COMBO PLUS V2)	
	AC	AF	RZ1	MZ1	RZ2	MZ2	LP	GP
1/2"	1/2"	1/2"	3/4"	3/4"	3/4"	3/4"	1/4" (6,35 mm)	5/8" (15,88 mm)



Flow rate/head graph SUPER TRIO (code 3.030395) direct zone

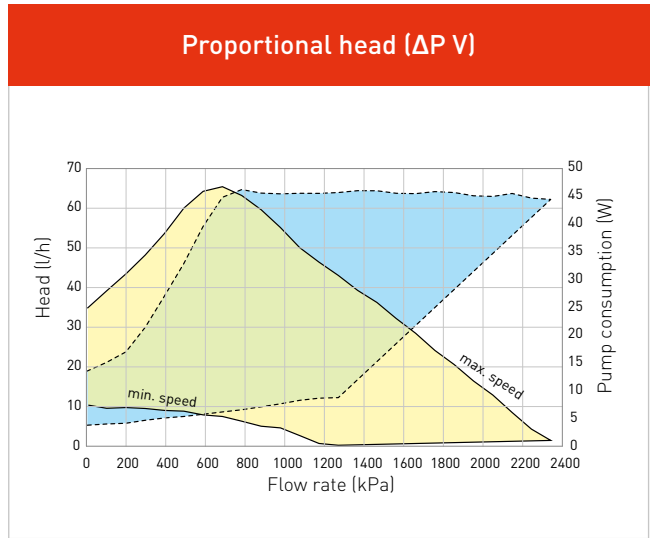
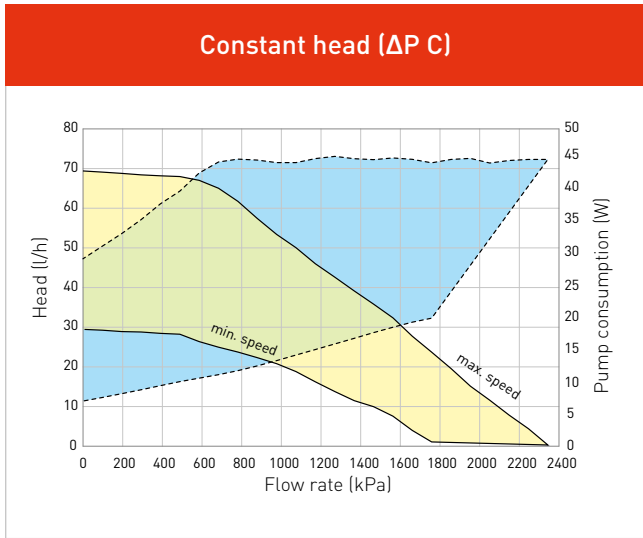

Flow rate/head graph ADDITIONAL MIXED 2ND ZONE KIT (code 3.027865)

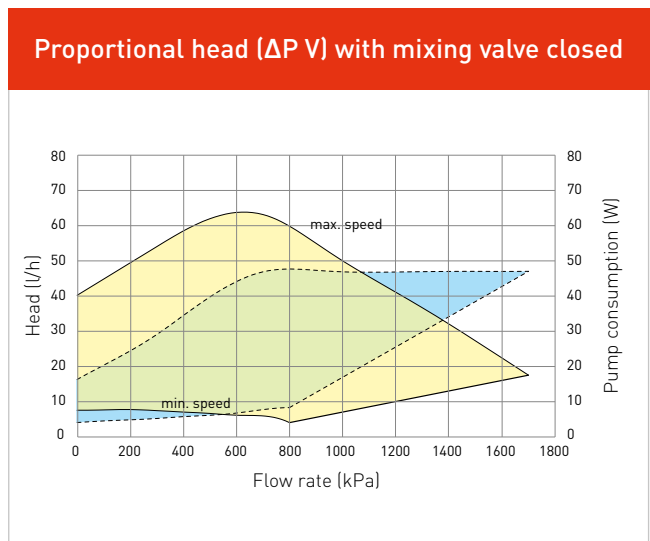
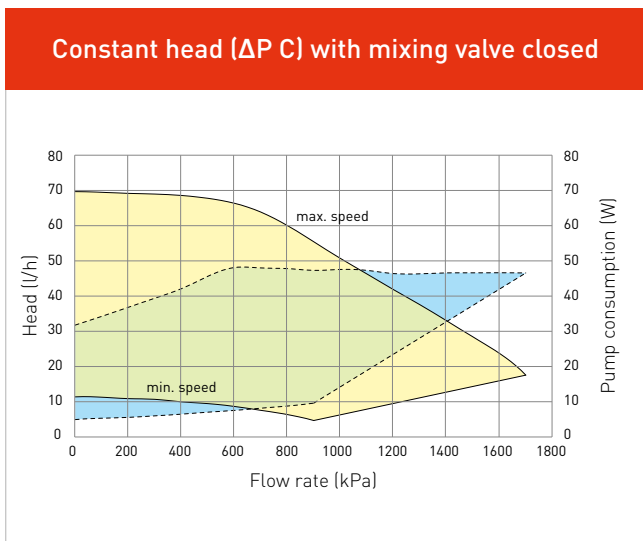
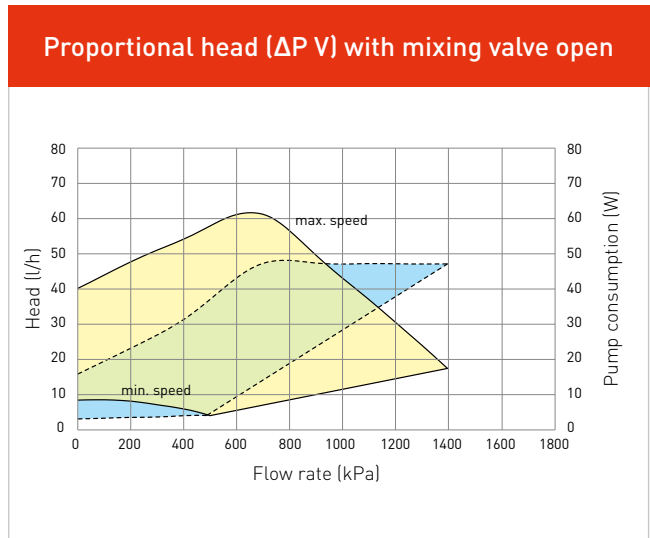
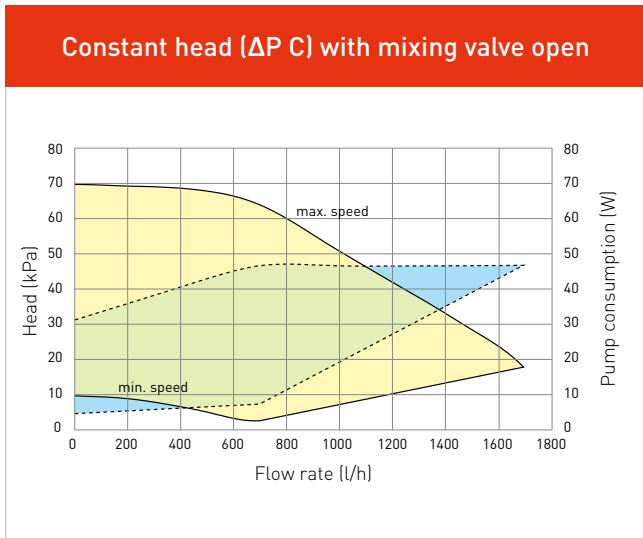

Key

- Available head in the system
- Pump consumption





Flow rate/head graph hydronic kit for MAGIS COMBO PLUS in SOLAR CONTAINER COMBO (code. 3.027867) direct zone

Constant head ( $\Delta P C$ )

Proportional head ( $\Delta P V$ )

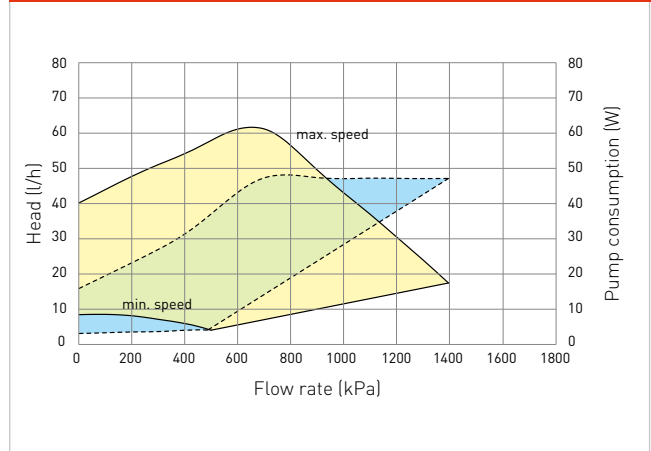
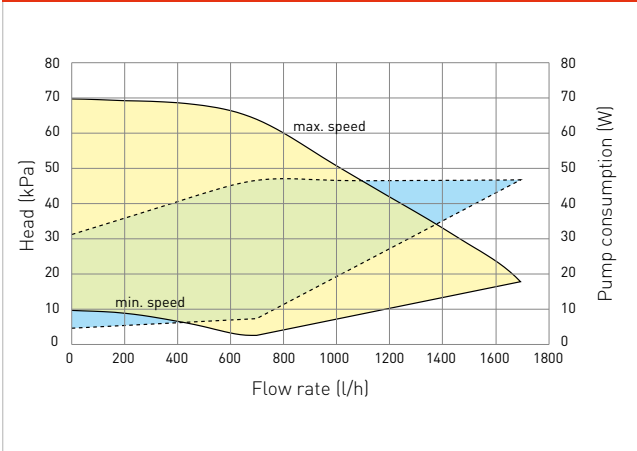

Flow rate/head graph ADDITIONAL MIXED 2ND ZONE KIT (code 3.027865)

Constant head ( $\Delta P C$ ) with mixing valve open

Proportional head ( $\Delta P V$ ) with mixing valve open

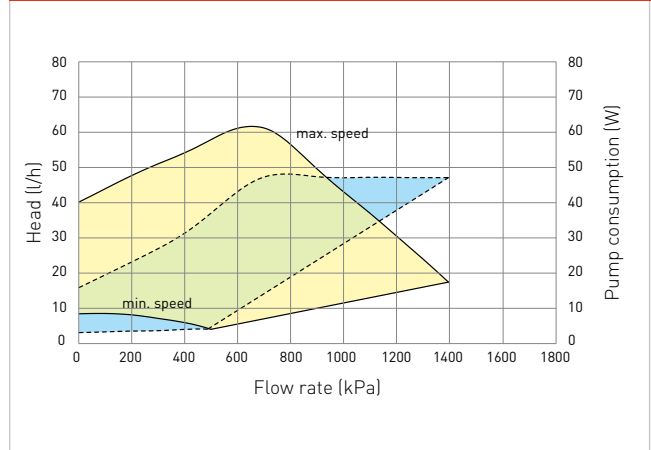
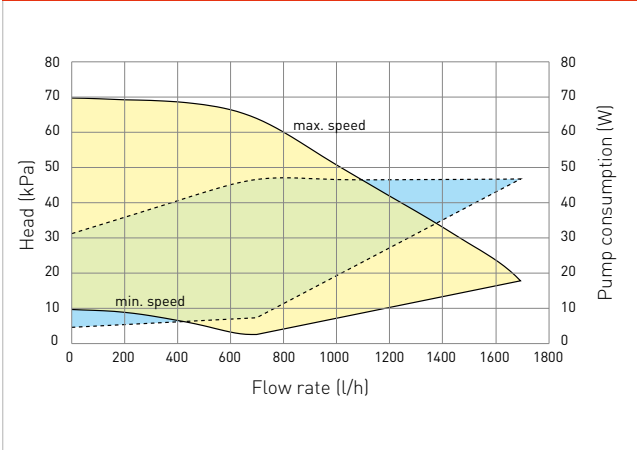

Constant head ( $\Delta P C$ ) with mixing valve closed

Proportional head ( $\Delta P V$ ) with mixing valve closed

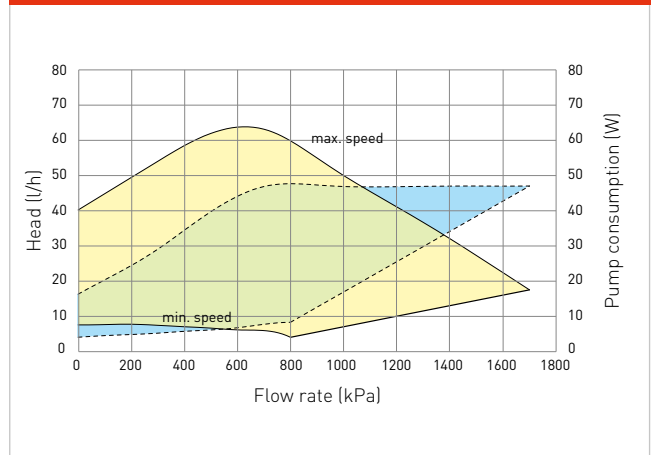
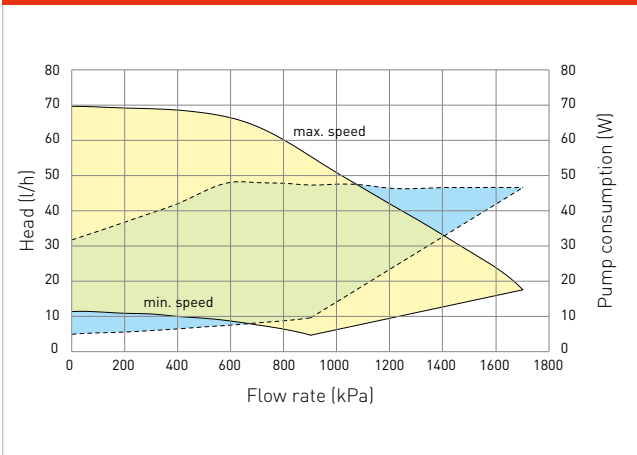

Key

- Available head in the system
- Pump consumption



Combining MAGIS COMBO/PLUS V2 with a heat regulation device is an excellent investment because it improves the seasonal energy efficiency of the heating system. For each of the following heat regulation devices we therefore indicate a class, which gives you the percentage value of increased efficiency.

## STANDARD INSTALLATION

## Remote control panel

Type		Code
<p>Modulating chronothermostat, remote control with temperature/humidity sensor.</p> <p>Temperature control class V* or VI Contribution to seasonal space heating energy efficiency 3%* or 4%</p>	 <p>Dimensions (H x W x D) mm 100 x 129 x 3</p>	3.030863

## CRONO 7

<p>ON-OFF Chronothermostat.</p> <p>Temperature control class IV* or VII Contribution to seasonal space heating energy efficiency 3%* or 4%</p>	 <p>Dimensions (H x W x D) mm 103 x 142 x 31</p>	3.021622
--	--	----------

Available also in WIRELESS version – code 3.021624

## Temperature/humidity active sensor kit

<p>To be used with radiant systems that also work in cooling mode. To make temperature requests, it is necessary to couple a chrono-thermostat code 3.021622 or 3.021624</p> <p>Temperature control class V or VI* Contribution to seasonal space heating energy efficiency 3% or 4%*</p>	 <p>Dimensions (H x W x D) mm 80 x 127 x 30</p>	3.030992
---	---	----------

## Room hygostat

<p>To be used with radiant systems that also work in cooling mode</p>	 <p>Dimensions (H x W x D) mm 70 x 115 x 40</p>	3.023302
---	---	----------

## External probe

<p>To be used when external probe as standard in outdoor condensing unit is not correctly exposed.</p> <p>Temperature control class: II*, VI or VII Contribution to seasonal space heating energy efficiency 2%*, 4% or 3,5%</p>		3.015266
--	--	----------

## 2 relays board kit

<p>To be used without system controller to manage dehumidifiers</p>		3.026302
---	--	----------

\* Temperature control class with default settings. Some heat regulation device can change class depending on the settings and operation modes that can be changed, for example Modulating or ON/OFF. The use of these devices contributes, in percentage, to the seasonal energy efficiency of the heating system. For more information about installation with SYSTEM CONTROLLER (code 3.021522) contact the presales-dept.

**Relay board kit**

Type		Code
To be installed inside internal unit, allows to manage the 3rd mixed zone		3.015350

**Safety thermostat kit**

For generators set up with low temperature		3.019229
--	--	----------

**Solar probe kit**

To be installed on domestic cold water inlet pipe (for MAGIS COMBO V2)		3.021452
--	--	----------

**Storage tank NTC probe kit**

To be used connected to commercial storage tank unit with MAGIS COMBO PLUS V2		3.019375
---	--	----------

**DOMINUS interface kit**

Wi-fi interface kit to remote control by App		3.026273
--	--	----------

**GSM telephonic control**

For buildings not equipped with telephone network		Dimensions (H x W x D) mm 198x78x30,5	3.017182
---	---	--	----------

**Telephonic remote control**



For buildings equipped with telephone network		Dimensions (H x W x D) mm 85 x 85 x 31	3.013305
---	--	---	----------



Inside the various range of options it is possible to find out complementary accessories for installing MAGIS COMBO V2, combi and PLUS version.

The use of original kits enhances quality and reliability of the products.

### Hydronic fancoils and accessories

Type		Code
HYDRO FS 200 Floor standing hydronic fancoil		3.028500
HYDRO FS 400 Floor standing hydronic fancoil		3.028501
HYDRO FS 600 Floor standing hydronic fancoil		3.028502
HYDRO FS 800 Floor standing hydronic fancoil		3.028503
HYDRO FS 1000 Floor standing hydronic fancoil		3.028505
HYDRO IN 200 Wall and ceiling built-in hydronic fancoil		3.029841
HYDRO IN 400 Wall and ceiling built-in hydronic fancoil		3.029842
HYDRO IN 600 Wall and ceiling built-in hydronic fancoil		3.029843
HYDRO IN 800 Wall and ceiling built-in hydronic fancoil		3.029844
HYDRO IN 1000 Wall and ceiling built-in hydronic fancoil		3.029845
Smart touch wall controller with temperature probe (black casing)* <b>NEW</b>		3.030877
Smart touch wall controller with temperature probe (white casing)* <b>NEW</b>		3.030878
On board electronic control with PID full modulating fan* <b>NEW</b>		3.030876
Sheet metal feet kit for HYDRO FS		3.028506
Modulating thermoregulation kit for HYDRO FS*		3.028509
4 speeds thermoregulation kit for HYDRO FS*		3.028510
Universal control board for commercial thermoregulation*		3.028511
Electronic control board with 0-10 V connection*		3.028512
Connection cable to shift water connections from left to right		3.029834
2-way group valve kit		3.028507
3-way group valve kit		3.028508
HYDRO 3 Wall-hung hydronic fancoil with remote control as standard.		3.027918
HYDRO 4 Wall-hung hydronic fancoil with remote control as standard.		3.027919
Connection kit for HYDRO 3/4 left exit		3.029520

\* It is mandatory to install one of these kits to operate the fancoil  
For the recessed installation of HYDRO IN, specific options are available on the dedicated documentation.

## OMNISTOR 300/500

**Stainless steel storage tank units** for DHW with oversized coil **Ideal for connection to heat pumps.**

The range of new OMNISTOR stainless steel storage tanks, is ideal to contain domestic hot water with an inspection flange at the lower part. The storage tanks are equipped with:



**1 stainless steel coils water/water** heat exchanger with oversized coil

**2 probe-supports and NTC probe** for Immergas heat pump connection

**Thermometer**

**Double magnesium anode**

**Suitable flexible insulation** which can be disassembled (6 cm thick on OMNISTOR 300 and 8 cm thick on OMNISTOR 500)

**Pre-arranged to fix pump station to the body of the storage tank with option kit** (maximum 4 solar flat plate-collectors)

**Pre-arranged to electric resistance kit** (option)

**Pre-arranged to double electronic anode** (option) code 3.025003

OMNISTOR 300

Model	Code	Capacity (litres)	Efficiency class	Dimensions (mm)		Material
				Height	External diameter	
OMNISTOR 300*	3.027910	276,8	C	1715	620	Stainless steel
OMNISTOR 500*	3.027911	480,3	C	1735	810	Stainless steel



\* The use of this storage tank unit involves the installation of an appropriately sized DHW expansion vessel and safety valve, not included in the supply.

### Options kits

Type	Code
Solar kit composed by: aesthetic cover frame, plate heat exchanger, single solar pump station (with low consumption circulation pump), solar central unit, connection insulated pipes.	3.029723
18 litres expansion vessels	3.019131
24 litres expansion vessels	3.019138
35 litres expansion vessels	3.019135
80 litres expansion vessels	3.019139



## Stainless steel storage tank unit\* for domestic hot water

Type		Code
UB INOX 120 V2 Equipped with 2 concentric coils water/water heat exchangers Efficiency class C		3.027818
UB INOX 200 V2 Equipped with 2 concentric coils water/water heat exchangers Efficiency class C		3.027819
UB INOX SOLAR 200 V2 Equipped with 2 coils water/water heat exchangers and solar circuit included Efficiency class C		3.027820
INOXSTOR 200 V2 Equipped with 2 coils water/water heat exchangers Efficiency class C		3.027746
INOXSTOR 300 V2 Equipped with 2 coils water/water heat exchangers Efficiency class C		3.027747

## Buffer tank with capacity of 75 litres

Wall-hung or floor-standing installation		3.027288
--	---	----------

## Wall-hung bracket kit

Wall-hung bracket kit for buffer tank 75 litres	3.027290
---	----------

## Distribution manifold kit for 1 direct and 1 mixed temperature zones

For direct connection to MAGIS COMBO V2 without system controller		3.026301
---	---	----------

## Anti freeze protection kit -15 °C

To protect internal unit MAGIS COMBO V2	3.017324
---	----------

## Anti-scale kit

For MAGIS COMBO V2 inside the building		3.017323
--	---	----------

\* Storage tank units can be connected to MAGIS COMBO V2 with connection in series (with the possibility to have pre-heated hot water from the solar system) or to MAGIS COMBO PLUS V2: in this application internal unit and heat pump work in the same delivery/return circuit of the storage tank.

## Dehumidifier kit

Type		Code
Dehumidifier kit* Only for recessed installation with codes 3.022146 and 3.022147		3.021529
Dehumidifier back frame kit*		3.022146
Dehumidifier front grille kit*		3.022147

\* Useful for radiant systems that work also in cooling.

## Wall-mounting bracket

Wall mounting brackets for external unit		3.022154
--	--	----------

## Condensate antifreeze heating cable kit

Condensate antifreeze heating cable kit for external unit		3.027385
---	--	----------

## Condensate discharge pump kit

Condensate discharge pump kit for internal unit		3.026374
---	--	----------

## 3-way diverter valve kit

To be used as diverter valve for heating/cooling switching		3.020632
--	---	----------

## Connection kit for R32 circuit **NEW**

For an easy connection of the refrigerant circuit, even in the case of pipes coming out from the wall on the internal unit MAGIS COMBO/PLUS V2.		3.030883
---	--	----------

### ZENITAIR-MONO

**Decentralised mechanical ventilation unit**, easy to install. Suitable for new building or restorations. Useful to complete the supply with our hybrid systems and only heat pump solutions.

- Decentralised Mechanical Ventilation unit, with alternate flow and heat recovery core.
- **Multifunction remote controller, with LCD display to visualise the status of the unit** supplied as standard.
- **Silent, efficient and easy to install.**
- Simplified synchronisation of more units (up to 10): thanks to a dedicated communication protocol the units get automatically synchronised when they are wired each other.
- Free cooling: extract only or intake only to prevent heat exchange when not needed.
- Automatic anti-frost protection to prevent frost building up on the heat exchanger.



Model	Code	Air-flow at different speed m3/h	Power consumption at different speed W	Thermal efficiency %
<b>ZENITAIR-MONO NEW</b> Mechanical bidirectional ventilation unit	3.030601	60/50/40/30/20	6/4,5/3,5/2,5/2	74





#### Option kit

Type	Code
<b>External cover kit with acoustical insulation for ZENITAIR-MONO NEW</b> anti-insect net and anti-wind in pre-painted steel	3.030636









Specific option for MAGIS COMBO PLUS V2 with SUPER TRIO

Type		Code
<p><b>CONTAINER for SUPER TRIO</b>(recessed frame) is the first of the components to be installed. It allows the housing of the main components (except the external unit AUDAX PRO V2). It acts as a template for the subsequent installation of internal unit, hydraulic components and the flue. Front access allows total system maintenance.</p>	 <p>Dimensions (H x W x D) mm 2200 x 1100 x 495</p>	3.030394
<p><b>DOMUS CONTAINER for SUPER TRIO</b> (technical box) is the first of the components to be installed. It allows the housing of the main components (except the external unit AUDAX PRO V2). Easily placed in any room of the house, it does not foresee wall predispositions. Front access allows total system maintenance.</p>	 <p>Dimensions (H x W x D) mm 2110 x 1160 x 520</p>	3.030393
<b>Aesthetic upper cover for DOMUS CONTAINER for SUPER TRIO</b>		3.030484
<p><b>Additional mixed 2nd zone kit</b> composed by: 1 low consumption pump, mixing valve and connection pipes. All components are insulated</p>		3.027865
<p><b>Solar kit</b> composed by: plate heat exchanger, single solar pump station (with low consumption circulation pump), solar central unit, connection pipes, 18 litre solar expansion vessel, temperature probes (for collectors and storage tank).  N.B.: For solar panel and other solar accessories see the solar catalogue.</p>		3.030482
<b>Recirculation kit*</b> (pump not included)		3.030483
<b>Anti scale kit*</b>		3.020628
<p><b>3-way diverter valve kit</b> to be used as diverter valve for heating/cooling switching</p>		3.020632
*Recirculation kit and Anti-scale kit can't coexist inside CONTAINER and DOMUS CONTAINER for SUPER TRIO.		
<b>Connection kit</b>		
Bottom connection kit		3.020575
Lateral connection kit		3.020574
Rear connection kit		3.020630



Specific option kits for MAGIS COMBO PLUS V2 in SOLAR CONTAINER COMBO

Type		Code
<p><b>SOLAR CONTAINER COMBO (recessed frame)</b> is the first of the components to be installed. It allows the housing of the main components (except the external unit AUDAX PRO V2).</p> <p>It acts as a template for the subsequent installation of internal unit, hydraulic components and the flue. Front access allows total system maintenance.</p>	 <p>Dimensions (H x W x D) mm 2200 x 950 x 430</p>	3.028187
<p><b>Additional mixed 2nd zone kit</b> composed by: 1 low consumption pump, mixing valve and connection pipes. All components are insulated</p>		3.027865
<p><b>Solar kit</b> composed by: plate heat exchanger, single solar pump station (with low consumption circulation pump), solar central unit, connection pipes, 12 litre solar expansion vessel, temperature probes (for collectors and storage tank).</p> <p>N.B.: For solar panel and other solar accessories see the Solar Catalogue</p>		3.024719
<p><b>Recessed Buffer tank 50 litres</b> for installation above or at the side of the SOLAR CONTAINER COMBO</p>	 <p>Dimensions (H x W x D) mm 410 x 950 x 350</p>	3.027709
<p><b>Anti-scale kit*</b></p>		3.020628
<p><b>Recirculation kit*</b> (pump not included)</p>		3.026169
<p><b>3-way diverter valve kit</b> to be used as diverter valve for heating/cooling switching</p>		3.020632

\*Recirculation kit and Anti-scale kit can't coexist inside CONTAINER and DOMUS CONTAINER for SUPER TRIO.

Connection kit

Bottom connection kit	3.020575
Lateral connection kit	3.020574
Rear connection kit	3.020630



 **IMMERGAS**





[immergas.com](http://immergas.com)



Immergas S.p.A.  
42041 Brescello (RE) - Italy  
T. 0522.689011  
F. 0522.689178

	<b>IMMERGAS</b> IMMERGAS SPA - ITALY CERTIFIED COMPANY UNI EN ISO 9001:2015
Design, manufacture and post-sale assistance of gas boilers, gas water heaters and related accessories	